

REVISIONS			
LTR	DESCRIPTION	DATE	APPROVED

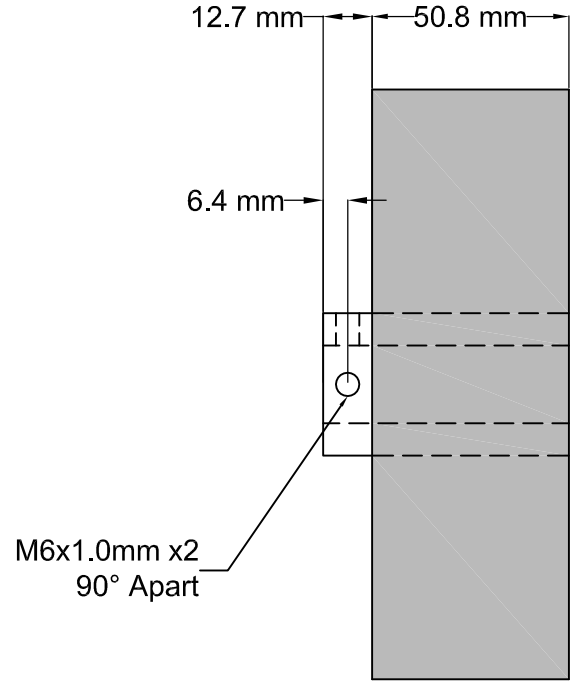

Durometer Options	
Replace XXX in Part Number with 3 letter durometer code from options below.	
40A = 40 SHORE A	80A = 80 SHORE A
55A = 55 SHORE A	90A = 90 SHORE A
70A = 70 SHORE A	

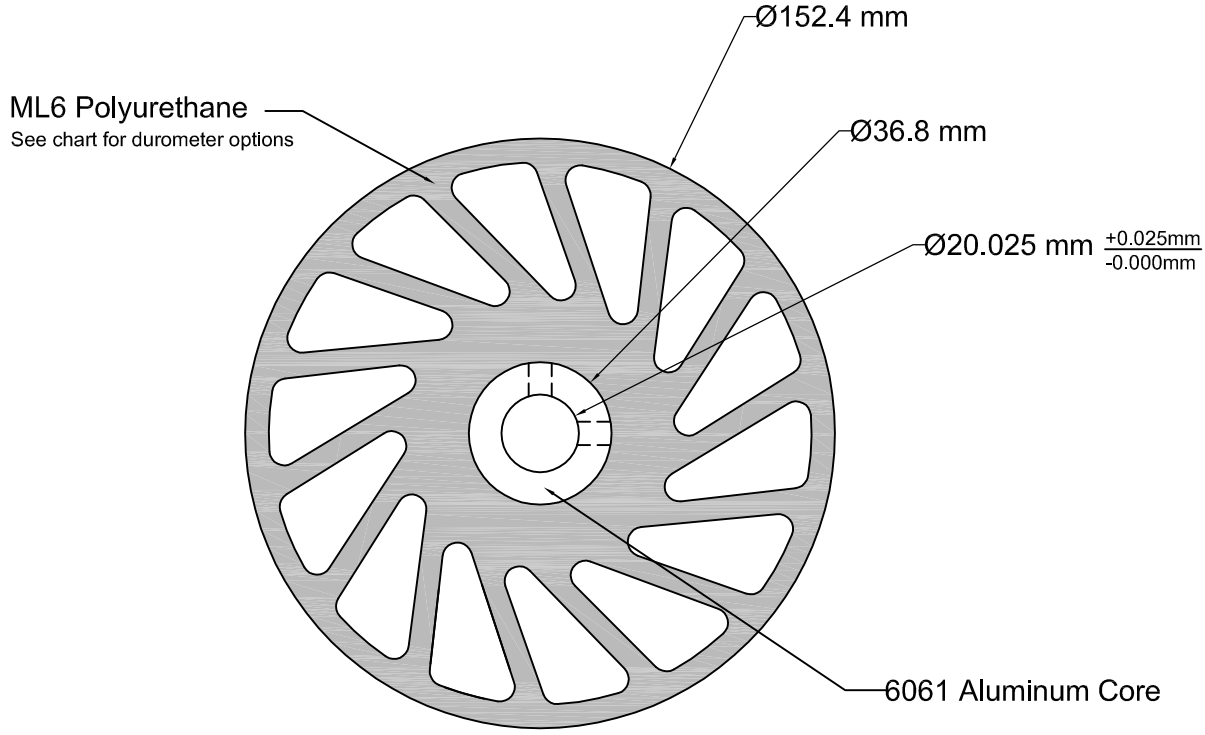

**MERIDIAN
LABORATORY**

2415 Pleasant View Rd. Middleton, WI 53562
(608) 836-7571 MeridianLab.com

This drawing is proprietary to Meridian Laboratory Inc. and may not be copied, disclosed, or distributed without explicit written permission. Design subject to change without notice.

UNLESS OTHERWISE SPECIFIED,
DIMENSIONS ARE IN INCHES AND
TOLERANCES ARE:

FRACTIONS	DECIMALS	ANGLES
±1/16	.X ± .1	±1/2°
	.XX ± .01	
	.XXX ± .005	

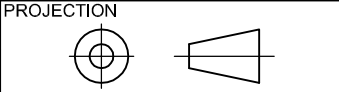

APPROVALS	DATE
DRAWN AG	2/8/23
CHECKED VRN	2/23/23
APPROVED	

TITLE 152.4mm x 50.8mm ML6 NO-CRUSH WHEEL			
PART NO. NCWM-620-XXX			
MATERIAL 6061 AL & ML6 PU OVERMOLD			
SCALE 2:1	REV. -	SHEET 1 of 1	ML6 CUST. BLOCK