

REVISIONS			
LTR	DESCRIPTION	DATE	APPROVED

ML6 Polyurethane  
See chart for durometer options

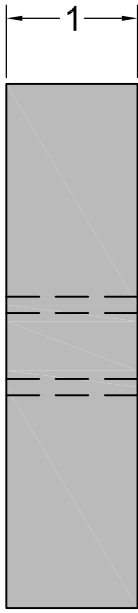
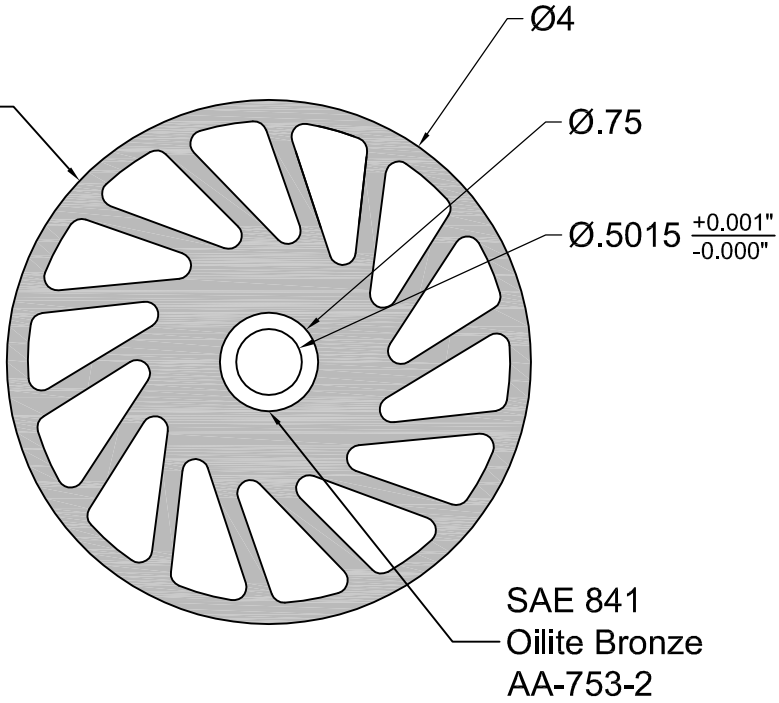

SAE 841  
Oilite Bronze  
AA-753-2

Durometer Options	
Replace <b>XXX</b> in Part Number with 3 letter durometer code from options below.	
<b>40A</b> = 40 SHORE A	<b>80A</b> = 80 SHORE A
<b>55A</b> = 55 SHORE A	<b>90A</b> = 90 SHORE A
<b>70A</b> = 70 SHORE A	



**MERIDIAN  
LABORATORY**

2415 Pleasant View Rd. Middleton, WI 53562  
(608) 836-7571 MeridianLab.com

This drawing is proprietary to Meridian Laboratory Inc. and may not be copied, disclosed, or distributed without explicit written permission. Design subject to change without notice.

UNLESS OTHERWISE SPECIFIED,  
DIMENSIONS ARE IN INCHES AND  
TOLERANCES ARE:  
FRACTIONS    DECIMALS    ANGLES  
±1/16        .X ± .1            ±1/2°  
                  .XX ± .01  
                  .XXX ± .005

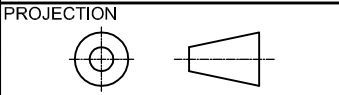

APPROVALS	DATE
DRAWN <b>AG</b>	<b>5/17/23</b>
CHECKED <b>VRN</b>	<b>5/17/23</b>
APPROVED	

TITLE <b>4.0" x 1.0" ML6 NO-CRUSH WHEEL</b>			
PART NO. <b>NCWOB-350-XXX</b>			
MATERIAL <b>SAE 841 OILITE BRONZE &amp; ML6 PU OVERMOLD</b>			
SCALE <b>3:2</b>	REV. <b>-</b>	SHEET <b>1 of 1</b>	ML6 CUST. BLOCK