

REVISIONS			
LTR	DESCRIPTION	DATE	APPROVED

ML6 Polyurethane
See chart for durometer options

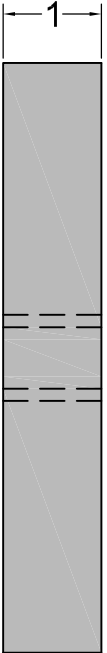
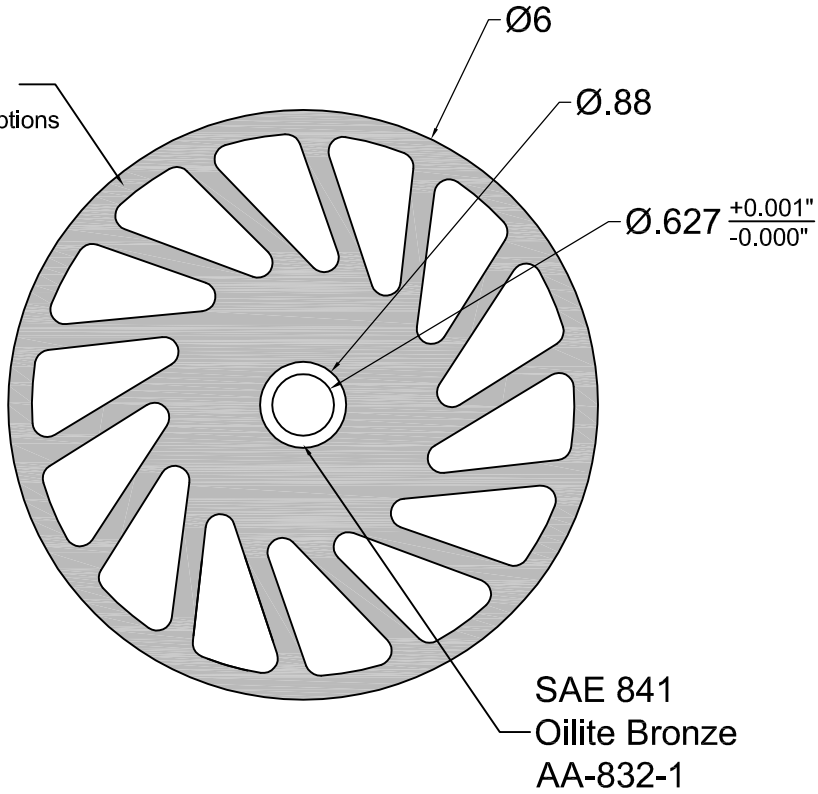

SAE 841
Oilite Bronze
AA-832-1

Durometer Options	
Replace XXX in Part Number with 3 letter durometer code from options below.	
40A = 40 SHORE A	80A = 80 SHORE A
55A = 55 SHORE A	90A = 90 SHORE A
70A = 70 SHORE A	



**MERIDIAN
LABORATORY**

2415 Pleasant View Rd. Middleton, WI 53562
(608) 836-7571 MeridianLab.com

UNLESS OTHERWISE SPECIFIED,
DIMENSIONS ARE IN INCHES AND
TOLERANCES ARE:
FRACTIONS DECIMALS ANGLES
±1/16 .X ± .1 ±1/2°
 .XX ± .01
 .XXX ± .005

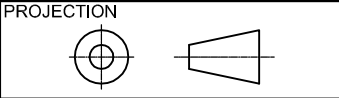

APPROVALS	DATE
DRAWN AG	5/25/23
CHECKED VRN	5/25/23
APPROVED	

TITLE	6.0" x 1.0" ML6 NO-CRUSH WHEEL		
PART NO.	NCWOB-560-XXX		
MATERIAL	SAE 814 OILITE BRONZE & ML6 PU OVERMOLD		
SCALE	2:1	REV.	-
SHEET	1 of 1	ML6 CUST. BLOCK	

This drawing is proprietary to Meridian Laboratory Inc. and may not be copied, disclosed, or distributed without explicit written permission. Design subject to change without notice.