

REVISIONS			
LTR	DESCRIPTION	DATE	APPROVED

ML6 Polyurethane
See chart for durometer options

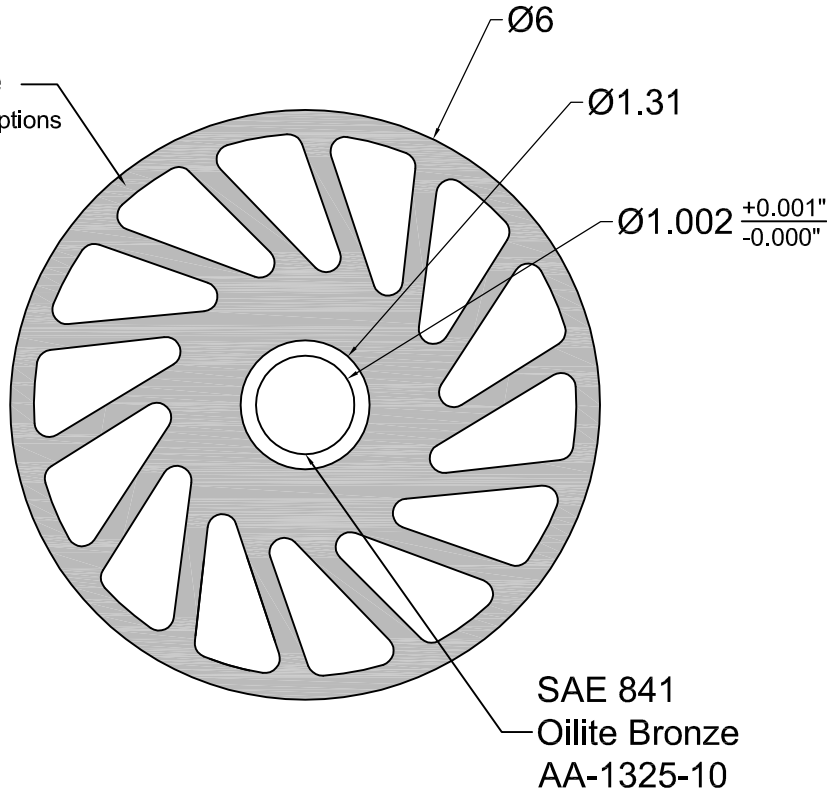

Durometer Options	
Replace XXX in Part Number with 3 letter durometer code from options below.	
40A = 40 SHORE A	80A = 80 SHORE A
55A = 55 SHORE A	90A = 90 SHORE A
70A = 70 SHORE A	



**MERIDIAN
LABORATORY**

2415 Pleasant View Rd. Middleton, WI 53562
(608) 836-7571 MeridianLab.com

UNLESS OTHERWISE SPECIFIED,
DIMENSIONS ARE IN INCHES AND
TOLERANCES ARE:

FRACTIONS	DECIMALS	ANGLES
±1/16	.X ± .1	±1/2°
	.XX ± .01	
	.XXX ± .005	

PROJECTION

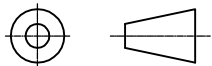

APPROVALS

DATE

TITLE

6.0" x 1.0" ML6 NO-CRUSH WHEEL

DRAWN

AG

5/25/23

PART NO.

NCWOB-580-XXX

CHECKED

VRN

5/25/23

MATERIAL

SAE 814 OILITE BRONZE & ML6 PU OVERMOLD

APPROVED

SCALE 2:1

REV. -

SHEET 1 of 1

ML6 CUST. BLOCK

This drawing is proprietary to Meridian Laboratory Inc. and may not be copied, disclosed, or distributed without explicit written permission. Design subject to change without notice.