

REVISIONS			
LTR	DESCRIPTION	DATE	APPROVED

ML6 Polyurethane
See chart for durometer options

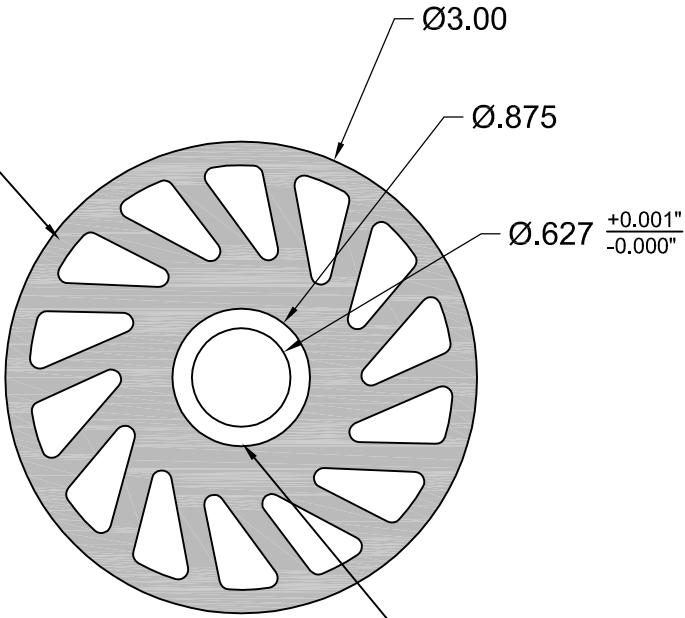

SAE 841
Oilite Bronze
AA-832-1

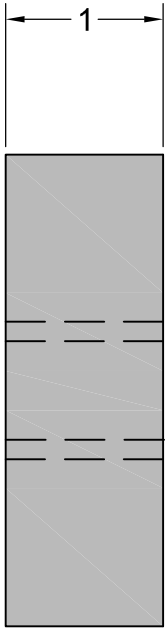

Durometer Options	
Replace XXX in Part Number with 3 letter durometer code from options below.	
40A = 40 SHORE A	80A = 80 SHORE A
55A = 55 SHORE A	90A = 90 SHORE A
70A = 70 SHORE A	



**MERIDIAN
LABORATORY**

2415 Pleasant View Rd. Middleton, WI 53562
(608) 836-7571 MeridianLab.com

This drawing is proprietary to Meridian Laboratory Inc. and may not be copied, disclosed, or distributed without explicit written permission. Design subject to change without notice.

UNLESS OTHERWISE SPECIFIED,
DIMENSIONS ARE IN INCHES AND
TOLERANCES ARE:
FRACTIONS DECIMALS ANGLES
±1/16 .X ± .1 ±1/2°
 .XX ± .01
 .XXX ± .005

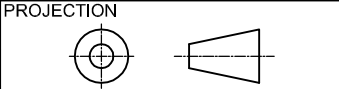

APPROVALS	DATE
DRAWN AG	05/08/23
CHECKED VRN	05/08/23
APPROVED	

TITLE 3.0" x 1.0" ML6 NO-CRUSH WHEEL			
PART NO. NCWOB-670-XXX			
MATERIAL SAE 841 OILITE BRONZE & ML6 PU OVERMOLD			
SCALE N/A	REV. -	SHEET 1 of 1	ML6 CUST. BLOCK